



EFL30 PRO

4-WHEEL LI-ION COUNTERBALANCE FORKLIFT 3.0T

 3000 kg  6000 mm  80 V Li-Ion



Built to perform across diverse environments, the EFL Pro Series excels in warehouses, factories, logistics centers, ports, and construction yards. Its high ground clearance, large tires and IPX4 water resistance enable operation on uneven outdoor terrain, while its compact turning radius and quiet, emission-free power make it ideal for indoor use as well. Designed to replace traditional diesel forklifts, the EFL Pro provides high performance with reduced operating costs

SPECIFICATION	REF	UNIT	VALUE
Battery type			Li-Ion
Battery nominal capacity K5		Ah	280
Battery voltage		V	80
Rated capacity	Q	kg	3000
Load centre distance	c	mm	500
Service weight		kg	4800
Height, mast lowered	h ₁	mm	2065
Lift	h ₃	mm	3000
Height, mast extended	h ₄	mm	4130
Overall length		mm	3627
Overall width	b ₁ /b ₂	mm	1210
Length to face of forks	l ₂	mm	2557
Fork dimensions	s/e/l	mm	45×122×1070
Turning radius		Wa	2352
Manufacturer			EP
Model designation			EFL30 PRO

Features

Unmatched Performance and great operator experience

Powered by a 17kW AC driving motor and 30kW PMS pump motor system, the EFL PRO achieves performance, gradeability and residual capacity in line with the best electric forklift with the advantage of the high ground clearance, the big size tires and robust chassis.

EFL PRO hydraulic system feature:

- Full-proportion solenoid valve for a more accurate micro-control
- PMS pump motor and screw type pump for precise and silent hydraulic operation
- Big diameter hydraulic tubing for high oil flow also on the attachments



Sleek Appearance with Enhanced Versatility

The EFL PRO Series combines a sleek, fully-molded design with outstanding stability, thanks to its extended 1753 mm wheelbase. Despite its robust stance, key dimensions—such as width and turning radius—remain comparable to standard electric forklifts, ensuring versatility in any application. Modern LED lighting enhances visibility and reinforces its contemporary look, while the electric parking brake and automatic stop on ramp further elevate safety and control

State of the art controls on the armrest

Multiple functions are integrated at the palm-size end with fingertip or joystick and includes:

forward/reverse direction switch, lifting/lowering, tilting, sideshift and 4th way, horn, turning light switch, Storage box and USB port, emergency switch

Optional: fork leveling button, clamp interlock button, 5th way button switch can complete the operator controls





Informative and Multi-functional Full-touch Display

The new OLED touchscreen display provides real-time monitoring of all key forklift operating parameters, including battery state of charge, driving speed, travel direction, wheel angle, operating hours, date and time. Optional functions such as and mast tilt angle, lift height and load weight indicators can also be integrated. Thanks to its touch interface, the operator can easily control all auxiliary systems, including the lighting system, wipers, and cabin heater.

Ergonomic Cabin for Fatigue-free and Convenient Operation

The EFL PRO's ergonomic design begins the moment the operator steps aboard, thanks to the largest access step in its class. Once inside, the EFL PRO features a offering a spacious driving area with a standard suspended seat with armrest. A reduced-size steering wheel, a tempered glass roof for enhanced visibility, and practical storage compartments further elevate the operator experience. For ease of service, power and auxiliary controllers are housed in a protected area accessible through removable panels.



Revolutionary Li-ion Battery and Charging System

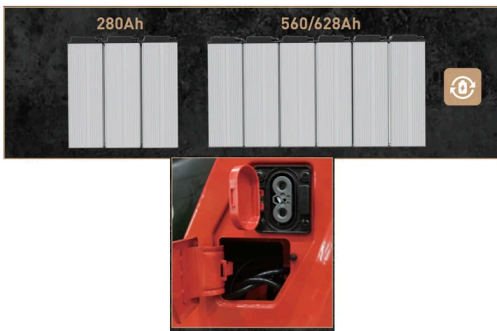

At the core of the EFL PRO Series is EP's breakthrough Li-ion technology — a new Li-ion battery system composed of three independent battery modules operating in series to achieve 80V. Each module functions autonomously, ensuring consistent performance and enhanced reliability. This battery architecture enables power from 280Ah to 560Ah or 628Ah, allowing the EFL PRO to adapt its endurance to a wide range of applications. Furthermore, through a dedicated upgrade kit, the dealer is able to adjust such battery power capacity to meet evolving customer requirements.

Additionally, each battery module can be repaired or replaced individually, eliminating the costly full-pack replacements typically required when single cells fail. For further charging convenience, both integrated charging and external charging port are available on one truck making EFL PRO flexible for all kinds of applications needs.

Complete configuration including Telematic and innovative options

EFL PRO comes standard with ergonomic armrest equipped with fingertip or joystick hydraulic controls, automatic speed reduction on turns and with telematic system that allows to manage the fleet and the rental activities in an effective and efficient manner. The system tracks data for truck and battery usage, like uptime, battery status and real-time location. It allows dealers to monitor and analyze assets conditions, providing remote diagnostics and improving the efficiency of fleet management.

The following items are available as optional equipment:

Full cabin with integrated heater on the dashboard and operator feet; Load-leveling function activated at the press of a single button; Load height indicator; Load weight indicator; Panoramic OHG with glass roof; 360°Panorama System with human recognition and collision warning (no CE); Ambient-noise Adaptive Buzzer(no CE).

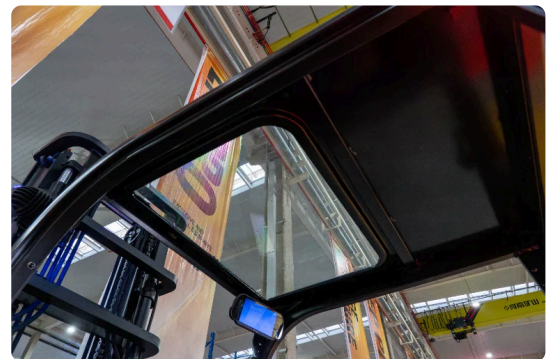

VDI Chart

	SPECIFICATION	REF	UNIT	VALUE
1.1	Manufacturer			EP
1.2	Model designation			EFL30 PRO

SPECIFICATION		REF	UNIT	VALUE
1.3	Drive			Electric
1.4	Operator type			Seated
1.5	Rated capacity	Q	kg	3000
1.6	Load centre distance	c	mm	500
1.8	Load distance, centre of drive axle to fork		mm	481
1.9	Wheelbase		mm	1753
2.1	Service weight		kg	4800
2.2	Axle loading, laden front/rear		kg	6923/873
2.3	Axle loading, unladen front/rear		kg	2234/2566
3.1	Tyres			Pneumatic
3.2	Tyre size, front		mm	28X9-15-14PR
3.3	Tyre size, rear		mm	6.50-10-10PR
3.4	Additional wheels (castor wheels)		mm	2x/ 2
3.5	Wheels, number front/rear (x=drive wheels)			2x/ 2
3.6	Tread width, front	b ₁₀	mm	1010
3.7	Tread width, rear	b ₁₁	mm	980
4.1	Tilt of mast/fork carriage forward/backward		°	6/ 6
4.2	Height, mast lowered	h ₁	mm	2065
4.3	Free lift		mm	135
4.4	Lift	h ₃	mm	3000
4.5	Height, mast extended	h ₄	mm	4130
4.7	Height of overhead guard (cabin)		mm	2170
4.8	Seat height relating to SIP/stand height		mm	1138
4.12	Coupling height		mm	510
4.19	Overall length		mm	3627
4.20	Length to face of forks	l ₂	mm	2557
4.21	Overall width	b ₁ /b ₂	mm	1210
4.22	Fork dimensions	s/e/l	mm	45×122×1070
4.23	Fork carriage ISO 2328, class/type A, B			3A
4.24	Fork carriage width		mm	1100
4.31	Ground clearance, laden, below mast		mm	130
4.32	Ground clearance, centre of wheelbase		mm	165
4.34.1	Aisle width for pallets 1000×1200 crossways		Ast	4033
4.34.2	Aisle width for pallets 800 × 1200 lengthways		Ast	4233

SPECIFICATION		REF	UNIT	VALUE
4.35	Turning radius		Wa	2352
5.1	Travel speed, laden/unladen		km/h	19/20
5.2	Lift speed, laden/unladen		m/s	0.55/0.58
5.3	Lowering speed, laden/unladen		m/s	0.43/0.44
5.5	Drawbar pull, laden/unladen			5924
5.6	Max. drawbar pull, laden/unladen			22350
5.8	Max. gradeability, laden/unladen		%	22/28
5.10	Service brake			Hydraulic
5.11	Parking brake			Electromagnetic
6.1	Drive motor rating S2 60 min		kW	17
6.2	Lift motor rating at S3 15%		kW	30
6.4	Battery nominal capacity K5		Ah	280
6.4	Battery voltage		V	80
6.4.1	Battery type			Li-Ion
6.5	Battery weight		kg	184
6.6	Energy consumption according to DIN EN 16796		kWh/h	8.75
6.7	Turnover output according to VDI 2198			180
6.8	Turnover efficiency according to VDI 2198			23.26
8.1	Type of drive unit			AC
10.1	Operating pressure for attachments		bar	180
10.2	Oil volume for attachments		ℓ/min	35
10.5	Steering design			Hydraulic
10.7	Sound pressure level at the driver's seat		dB(A)	< 70

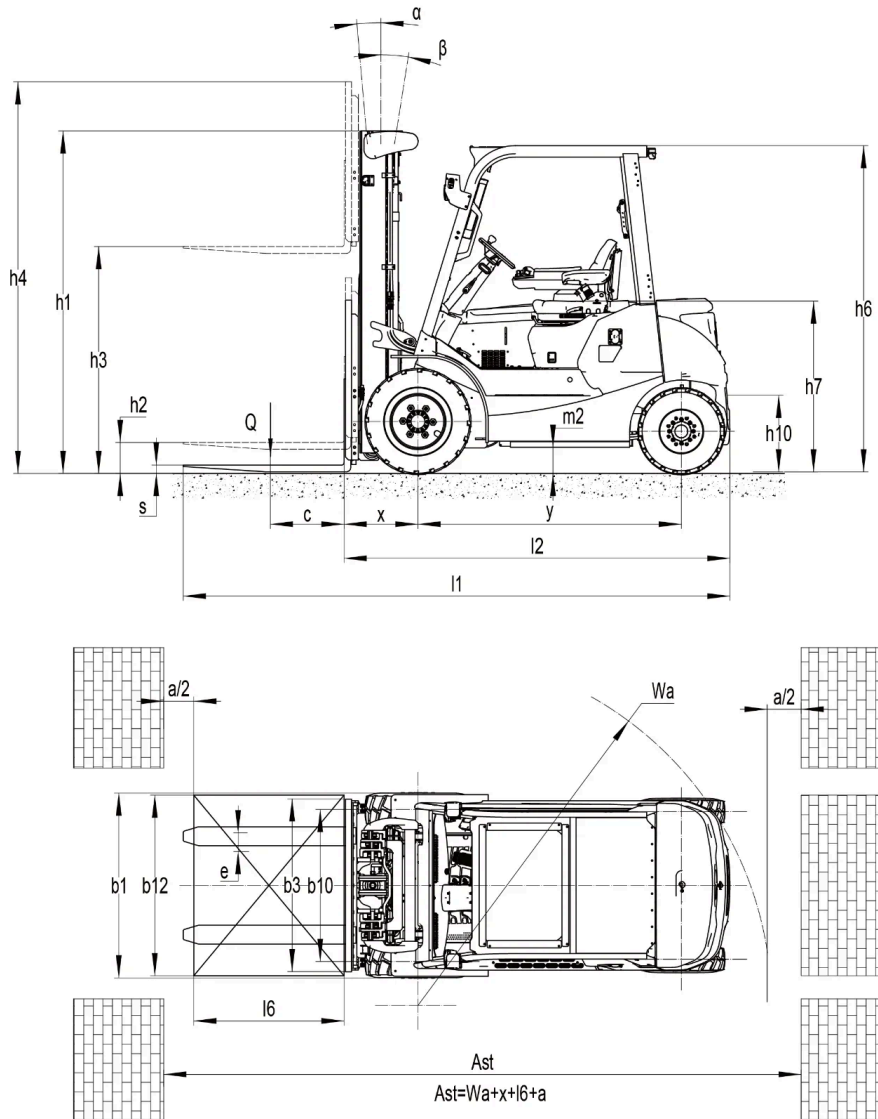

EFL 30 PRO

RATED CAPACITIES GRAPH

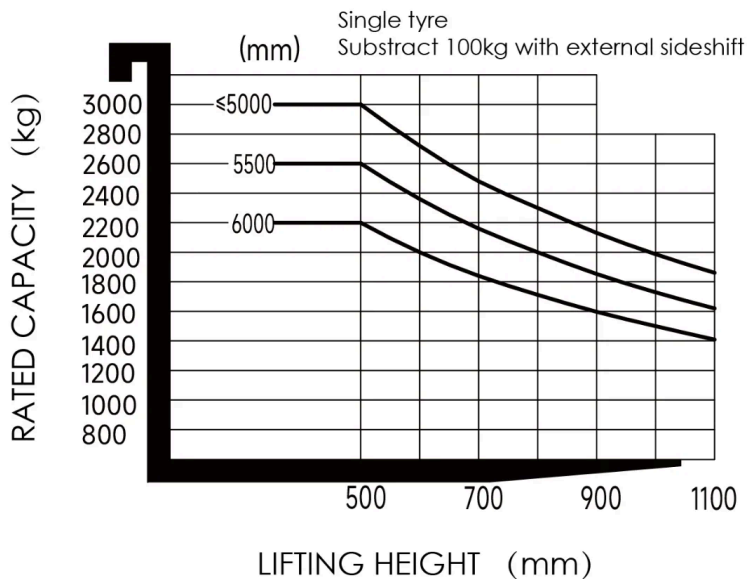

Mast Options

MAST TYPE	LIFT HEIGHT (H3, MM)	MAST LOWERED HEIGHT (H1, MM)	MAST EXTENDED HEIGHT, NO BACKREST (H4, MM)	MAST EXTENDED HEIGHT, WITH BACKREST (H4, MM)	FREE LIFT HEIGHT, NO BACKREST (H2, MM)	FREE LIFT HEIGHT, WITH BACKREST (H2, MM)	FORWARD TILT (A, DEG)	BACKWARD TILT (B, MM)	LOAD DISTANCE (X, MM)
2-Standard Mast	2700	1915	3365	3830	135	135	6	6	481
2-Standard Mast	3000	2065	3665	4130	135	135	6	6	481
2-Standard Mast	3300	2215	3965	4430	135	135	6	6	481
2-Standard Mast	3500	2315	4165	4630	135	135	6	6	481
2-Standard Mast	3600	2365	4265	4730	135	135	6	6	481
2-Standard Mast	4000	2615	4665	5130	135	135	6	6	481
2-Standard Mast	4500	2865	5165	5630	135	135	6	6	481
2-Free Mast	3000	2090	3715	4175	1455	995	6	6	481
2-Free Mast	3300	2195	4015	4475	1560	1100	6	6	481
2-Free Mast	3600	2345	4315	4775	1710	1250	6	6	481
3-Free Mast	4300	2080	5030	5435	1390	985	6	6	492
3-Free Mast	4500	2160	5270	5675	1470	1065	6	6	492

MAST TYPE	LIFT HEIGHT (H3, MM)	MAST LOWERED HEIGHT (H1, MM)	MAST EXTENDED HEIGHT, NO BACKREST (H4, MM)	MAST EXTENDED HEIGHT, WITH BACKREST (H4, MM)	FREE LIFT HEIGHT, NO BACKREST (H2, MM)	FREE LIFT HEIGHT, WITH BACKREST (H2, MM)	FORWARD TILT (A, DEG)	BACKWARD TILT (B, MM)	LOAD DISTANCE (X, MM)
3-Free Mast	4800	2265	5570	5975	1575	1170	6	6	492
3-Free Mast	5000	2350	5720	6125	1660	1255	6	6	492
3-Free Mast	5500	2600	6220	6625	1910	1505	6	6	492
3-Free Mast	6000	2850	6720	7125	2160	1755	6	6	492

Options

ITEM	OPTIONS (optional items marked in yellow)
Fork dimension	122*45*1070 122*45*1150 122*45*1220 122*45*1370 122*45*1520
Front wheel material	Pneumatic Normal solid Traceless solid
Rear wheel material	Pneumatic Normal solid Traceless solid
Battery capacity	80V280AH 80V560AH 80V628AH (NON-CE)
Charger	80V65A (NON-CE) 80V60 (CE) 80V35A Integrated 80V60A Integrated 80V130A 80V150A 80V200A (560/628AH)
Battery display indicator (BDI)	With time (Bluetooth)
Seat type	Comfortable + safety belt switch (41) Suspension seat with armrest and safety belt swich GRAMMER-MSG65
Attachments	Built-in sideshifter External shifter Fork position with sideshift External shifter with adjustable forks Clamp
Traction pin	Yes and not customized
Anti-static chain	Yes and not customized
Front lamp	LED
Rear lamp	No LED
Warning lamp	Yes and not customized
Steering lamp	LED
Blue lamp	No Rear Front and rear
Area warning lamp	No Both sides Both sides and rear
Rearview mirror	One in front Two on sides and one in front
Buzzer	Regular buzzer Ambient-noise adaptive buzzer (NON-CE)
OPS system	Yes and not customized

ITEM	OPTIONS (optional items marked in yellow)
USB interface	Cigarette lighter+USB with A and C type
Telematics	Yes and not customized No
Cabin	Roof and front windshield Semi-Cabin Full Cabin with heater Full cabin with double heater Roof
Overhead guard	Strip glass with anti-explosion film Panoramic glass roof
Clamp interlock	No Yes and not customized
Special AUS/NZ options	No Yes and not customized
Turn speed control	Yes and not customized No
Heating system during lithium battery charging	No Yes and not customized
Operator identification device	No Card reader
Lifting electronic limit	No Yes and not customized
Hydraulic control	Joystick fingertip
Rear armrest horn	Yes and not customized
Area Speed Limit System	No Yes and not customized
Weighing system	No Yes and not customized
Automatic fork leveling	No Yes and not customized
Wiper water unit	Yes only with Cabin
Automatic Parking Brake	Yes and not customized
Height display+Forward tilt speed limit+High-position lateral shift speed control	No Yes and not customized
Surround View System+Human recognition system	No Yes and not customized (NON-CE)